

DIY

powered by **hypex electronics**

/CLASS D

**Assembly
Instructions**

PreAmplifier

Basic kit

Table of Contents

Chapter	Page
Tools	2
Parts	2
Safety precautions	5
Assembly	6
Case	7
Backpanel	8
Optional future add-on	9
Supply	10
Main	11
Frontboard & Headphone	12
Cables	13
Lid & Frontpanel	16
Support	19
Warranty	19
Disclaimer	19
Revisions	19
Notes	19

Tools

not included:

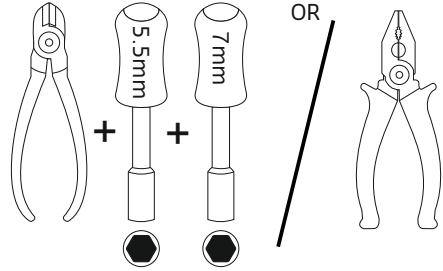

Included:

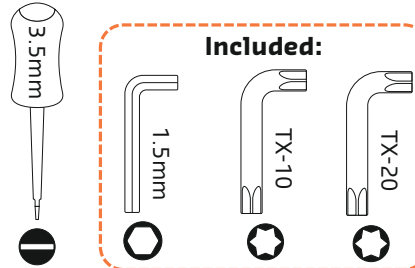

Parts

Electronics

1x **EL-1**

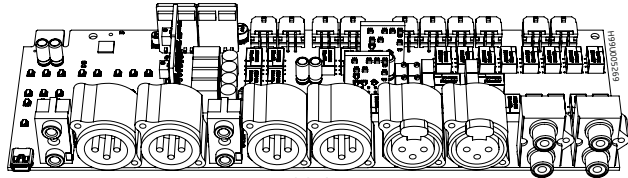

Main

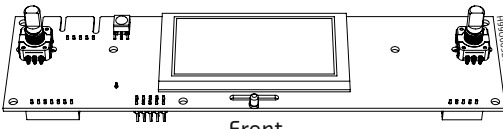

1x **EL-2**

Front

1x **EL-3**

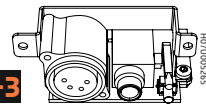

Headphone

1x **EL-4**



Switch

1x **EL-5**

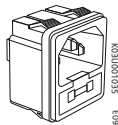

Terminal

1x **EL-6**

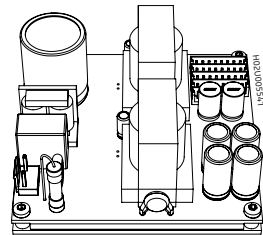

Supply

Case

1x **CA-1**

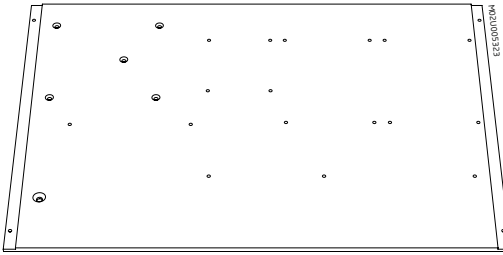

Bottom

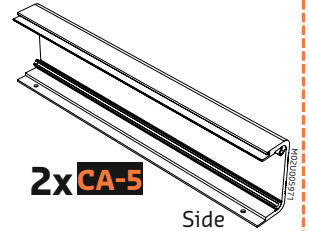

2x **CA-5**

Side

1x **CA-2**

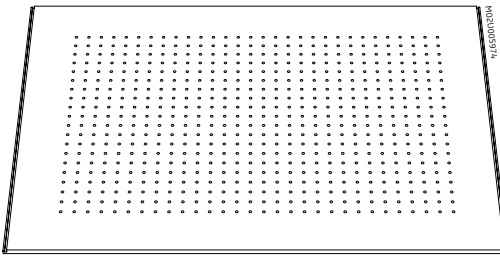

Top

2x **CA-6**

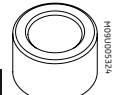

Knob

4x **CA-7**



Foot

1x **CA-3**

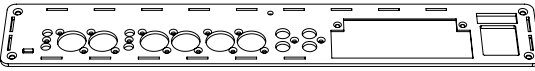

Back

1x **CA-8**



Panel Blind

1x **CA-4**

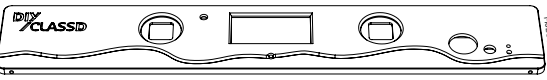

Front

Mounting set Case



2x **MC-1**



M4x10



M4x10



4.5mm

5x **MC-2**

4x **MC-3**

8x **MC-4**



4.5mm



4.3mm



M4



M3x10



3.3mm



M3x5

1x **MC-5**

1x **MC-6**

1x **MC-7**

4x **MC-8**

4x **MC-9**

2x **MC-10**

Cable set Basic

1x **CB-1**



Z1A10L4

1x **CB-2**



Z1A11L1

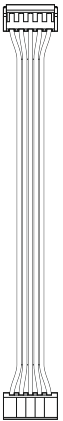

Z5C11L1

1x **CB-3**

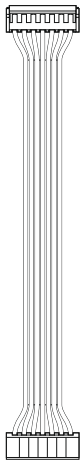

Z7C12L1

1x **CB-4**

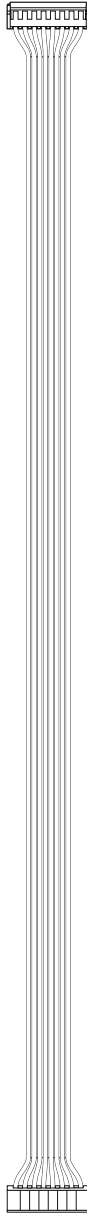

Z8C35L1

1x **CB-5**



Z2A29L1

1x **CB-6**



Z4B34L1

2x **CB-7**

Mounting set Basic

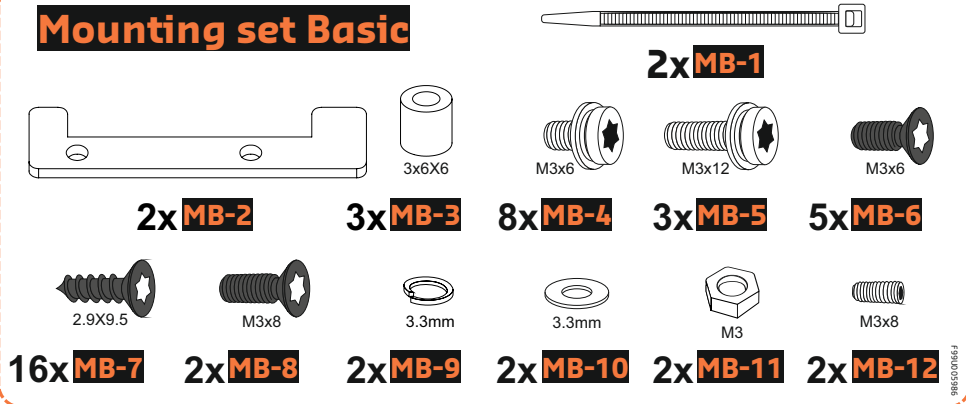

Safety precautions

This unit operates at mains voltage and carries hazardous voltages at accessible parts. These parts may never be exposed to inadvertent touch. Observe extreme care during installation and never touch the internal modules while the unit is connected to the mains. Disconnect the unit from the mains and allow all capacitors to discharge for 10 minutes before handling it.

Damage due to inappropriate handling is not covered by warranty. This product has no user-serviceable parts.

Warning: To reduce the risk of fire or electric shock, do not expose this device to rain or moisture.

Précautions de sécurité

Ce unité est sous tension secteur et certaines de ses pièces accessibles sont sous une tension dangereuse. Ces pièces doivent dans tous les cas être protégées contre contacts accidentels. Lors de l'installation, une prudence extrême s'impose. Ne jamais toucher les pièces du module quand celui-ci est relié au secteur. Isoler l'appareil du secteur et attendre 10 minutes pour laisser à tous les condensateurs le temps de se décharger avant de le manipuler.

Les dommages causés par un usage non approprié sont exclus de la garantie.

Ce produit ne contient aucune pièce devant être entretenue par l'utilisateur.

Avertissement: Pour réduire les risques de choc électrique, ne pas exposer cet appareil à la pluie ou l'humidité.

 Attention: Observe precautions for handling electrostatic sensitive devices. This module uses semiconductors that can be damaged by electrostatic discharge (ESD).

1. Read these instructions.
2. Heed all warnings.
3. Follow all instructions.
4. Clean only with a dry cloth.
5. Do not assemble this apparatus near water.
6. Only use attachments/accessories specified by the manufacturer.
7. Never connect a power cord to this apparatus before the assembly is finished which include:
 - Proper installation of all parts.
 - Correct connections of all cables.
 - Firmly closed case.
8. Before operating this apparatus:
 - Read and understand the corresponding User Manual in addition to this Assembly Instruction.
9. Refer all servicing to qualified service personnel. Servicing is required when the apparatus has been damaged in any way, such as power-supply cord or plug is damaged, liquid has been spilled or objects have fallen into the apparatus, the apparatus has been exposed to rain or moisture, does not operate normally, or has been dropped.
10. Changes or modifications not expressly approved by Hypex Electronics will void compliance and therefore the user's authority to operate the equipment.
11. Service or modifications by any person or persons other than by Hypex Electronics authorized personnel voids the warranty.



Correct disposal of this product: This symbol indicates that this product should not be disposed of with your household waste, according to the WEEE directive (2012/19/EU) and your national law. This product should be handed over to an authorized collection site for recycling waste electrical and electronic equipment (EEE). Improper handling of this type of waste could have a possible negative impact on the environment and human health due to potentially hazardous substances that are generally associated with EEE. At the same time, your cooperation in the correct disposal of this product will contribute to the effective usage of natural resources. For more information about where you can drop off your waste equipment for recycling, please contact your local city office, waste authority, or your household waste disposal service.

Assembly

Result

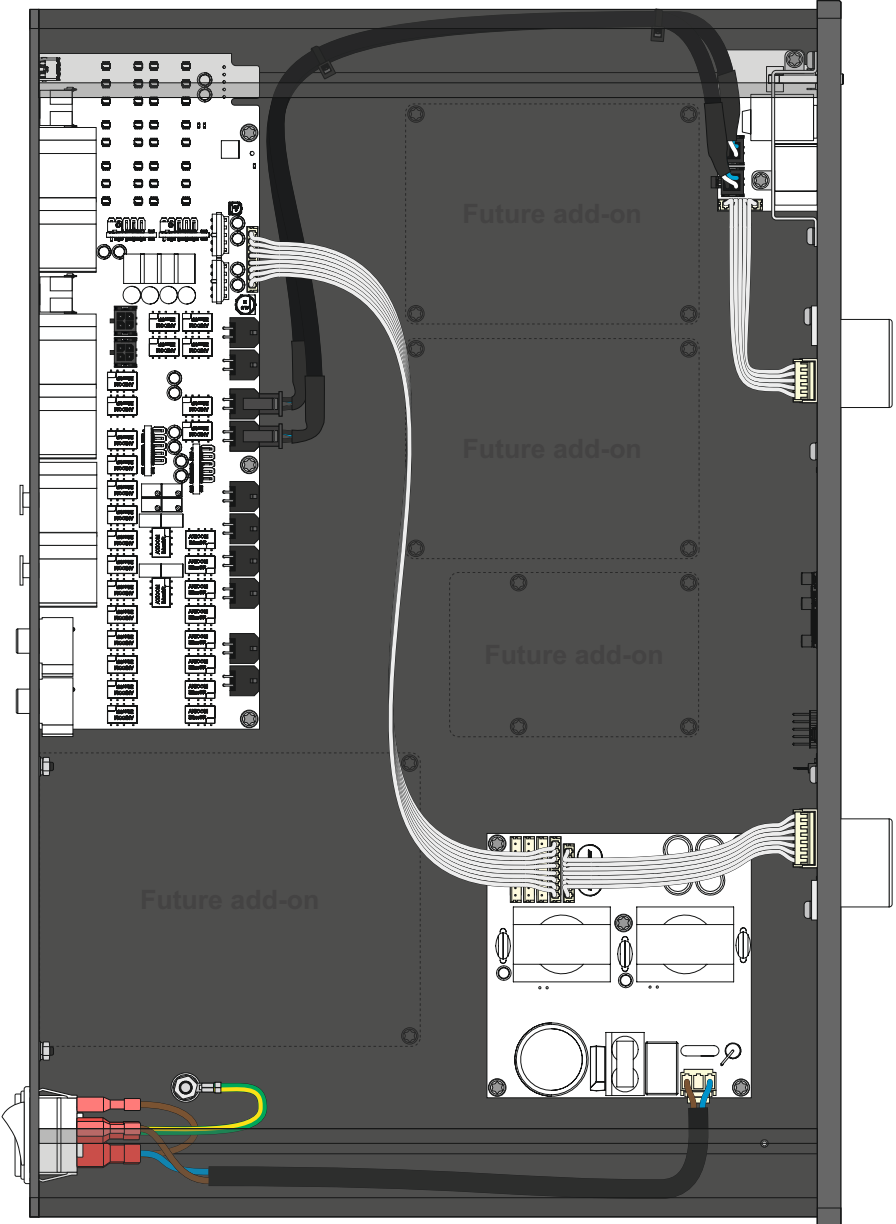

Case

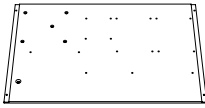

1x **CA-1**

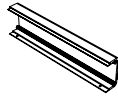

2x **CA-5**



4x **CA-7**

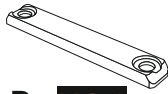

2x **MC-1**



4x **MC-3**



4x **MC-4**



4x **MC-8**



4x **MC-9**

1

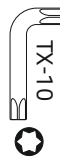
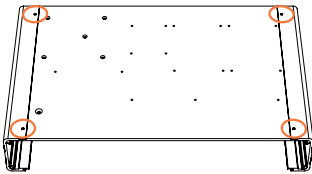

4x

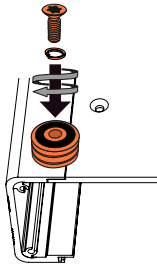

2

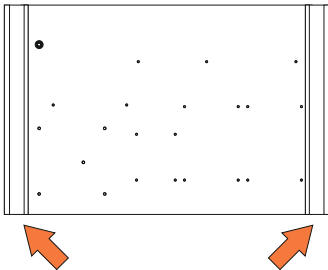

2x

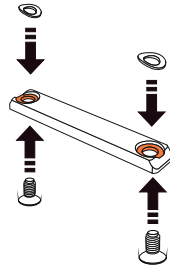

MC-3

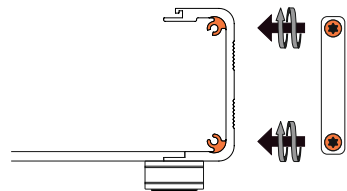
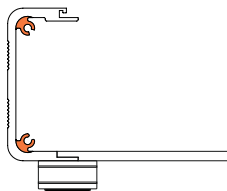
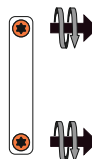

Backpanel

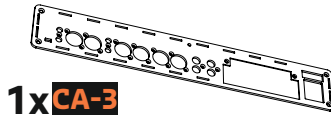

2x **MB-8**



2x **MB-9**



2x **MB-10**



2x **MB-11**



4x **MC-2**



4x **MC-4**



1x **EL-4**

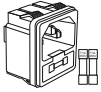

1x **EL-5**



1x **CB-1**



1x **CB-2**



1x **CB-6**

1

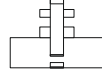
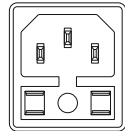
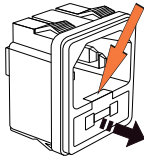

2

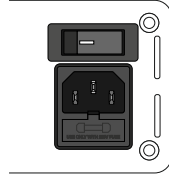
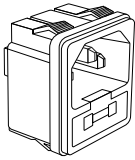
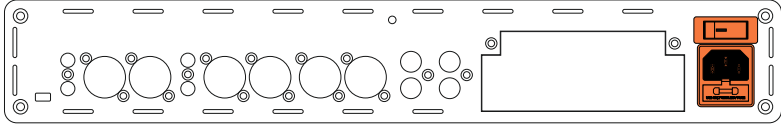

3
4
5

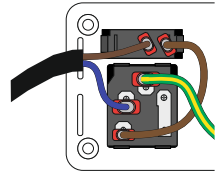

3

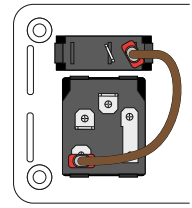
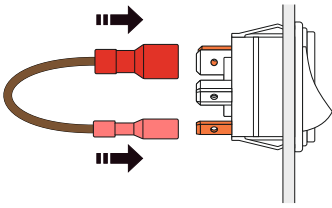

4

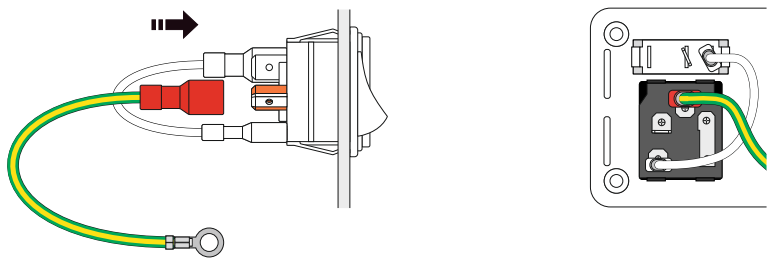

5

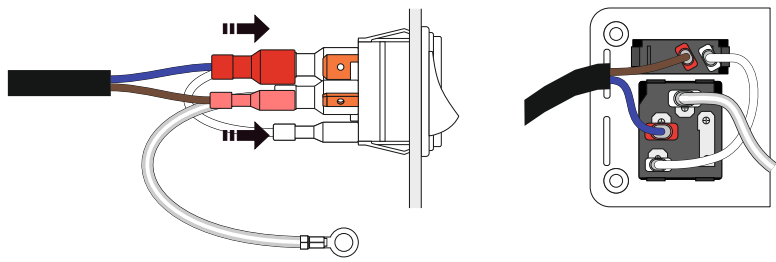

6

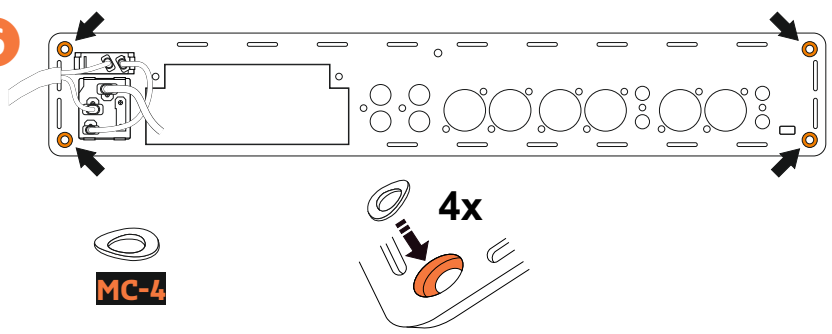

7

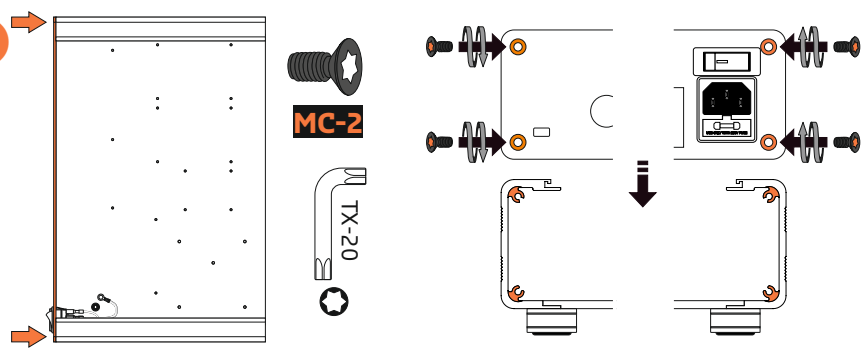

Optional In case of optional add-on: read accompanying instructions now. 

8

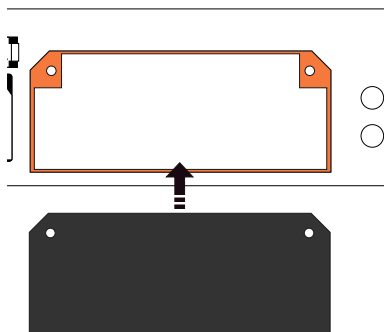
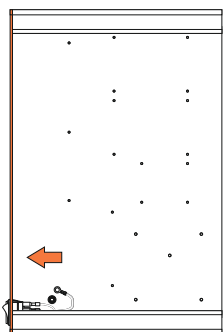

9

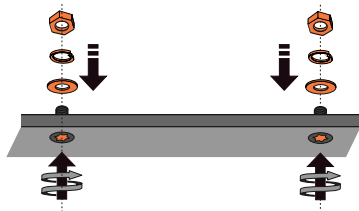
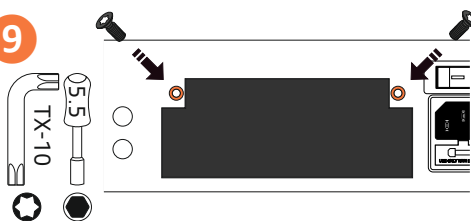

Supply

1x **EL-6**

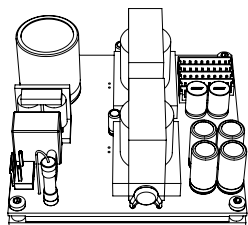

5x **MB-6**

1

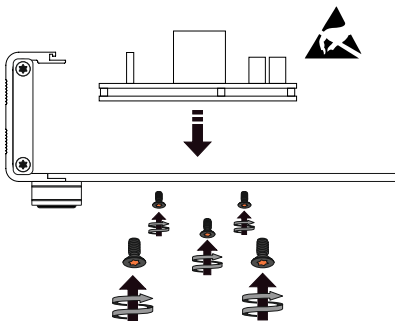
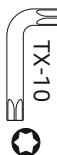
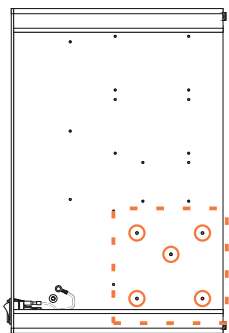

Main

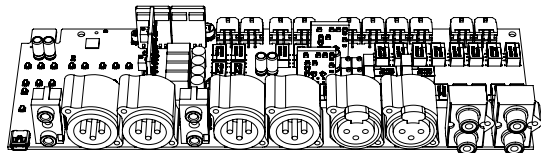

1x **EL-1**



3x6x6

3x **MB-3**



M3x12

3x **MB-5**



2.9x9

16x **MB-7**

1

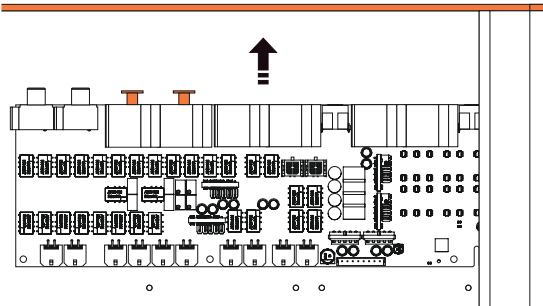
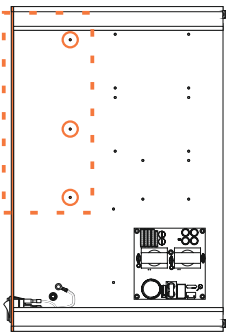

2



MB-7

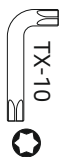

TX-10

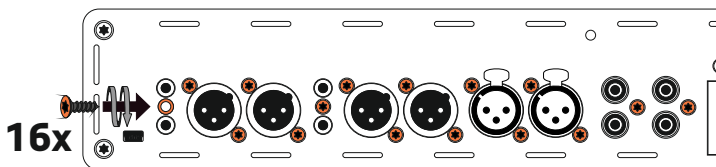
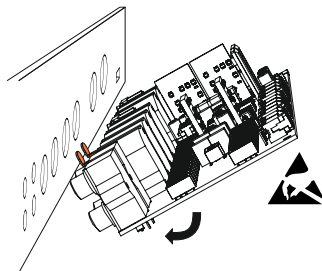

16x

3

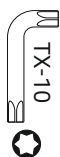

TX-10

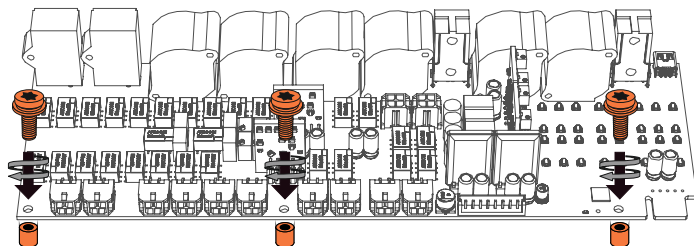

Frontboard & Headphone

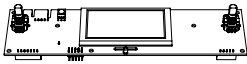

1x **EL-2**

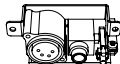

1x **EL-3**

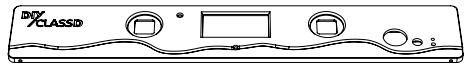

1x **CA-4**

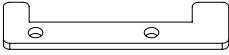

2x **MB-2**



8x **MB-4**



2x **MC-10**

1

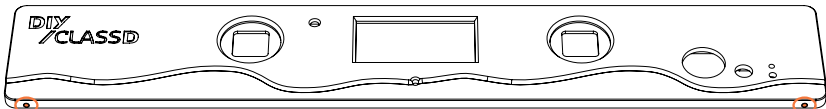

2x



MC-10

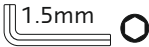

2x

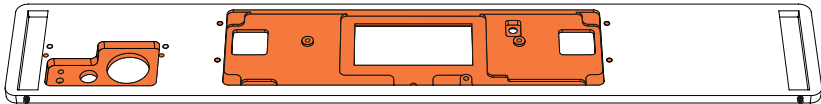

2



2x **MB-4**



TX-10

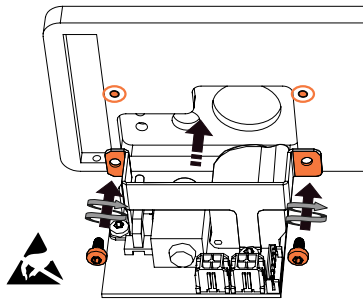

3

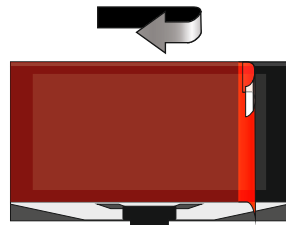
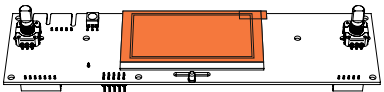

4



6x **MB-4**

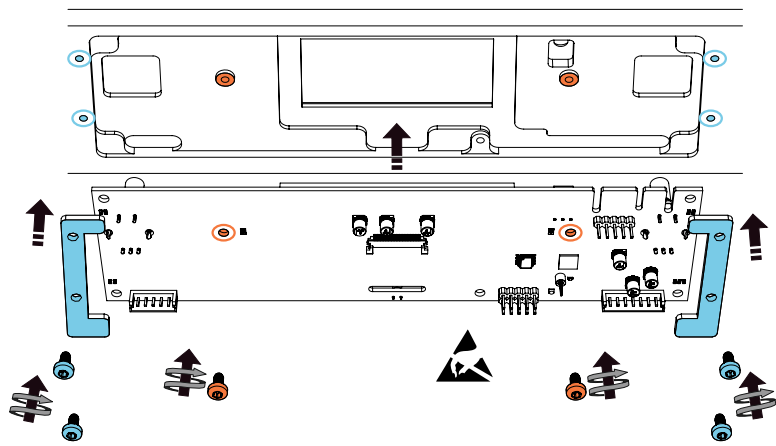

Cables



M4x10

1x **MC-2**



4.5mm

1x **MC-5**



4.3mm

1x **MC-6**



M4

1x **MC-7**

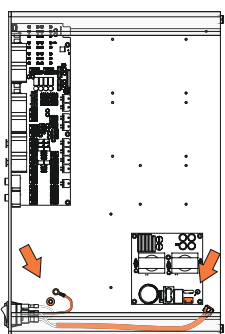

1

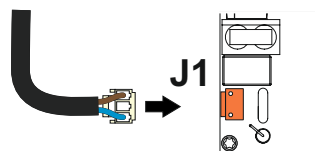

2

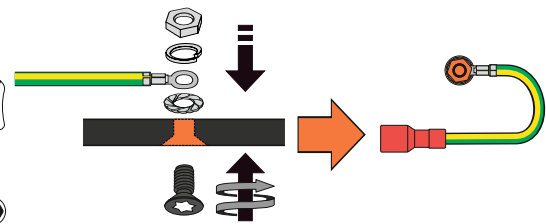

3

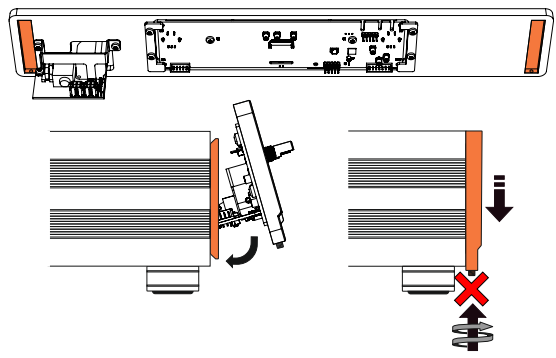
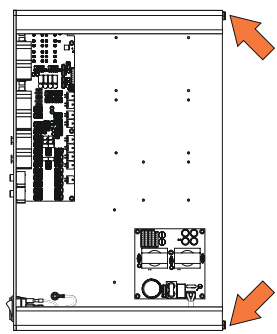

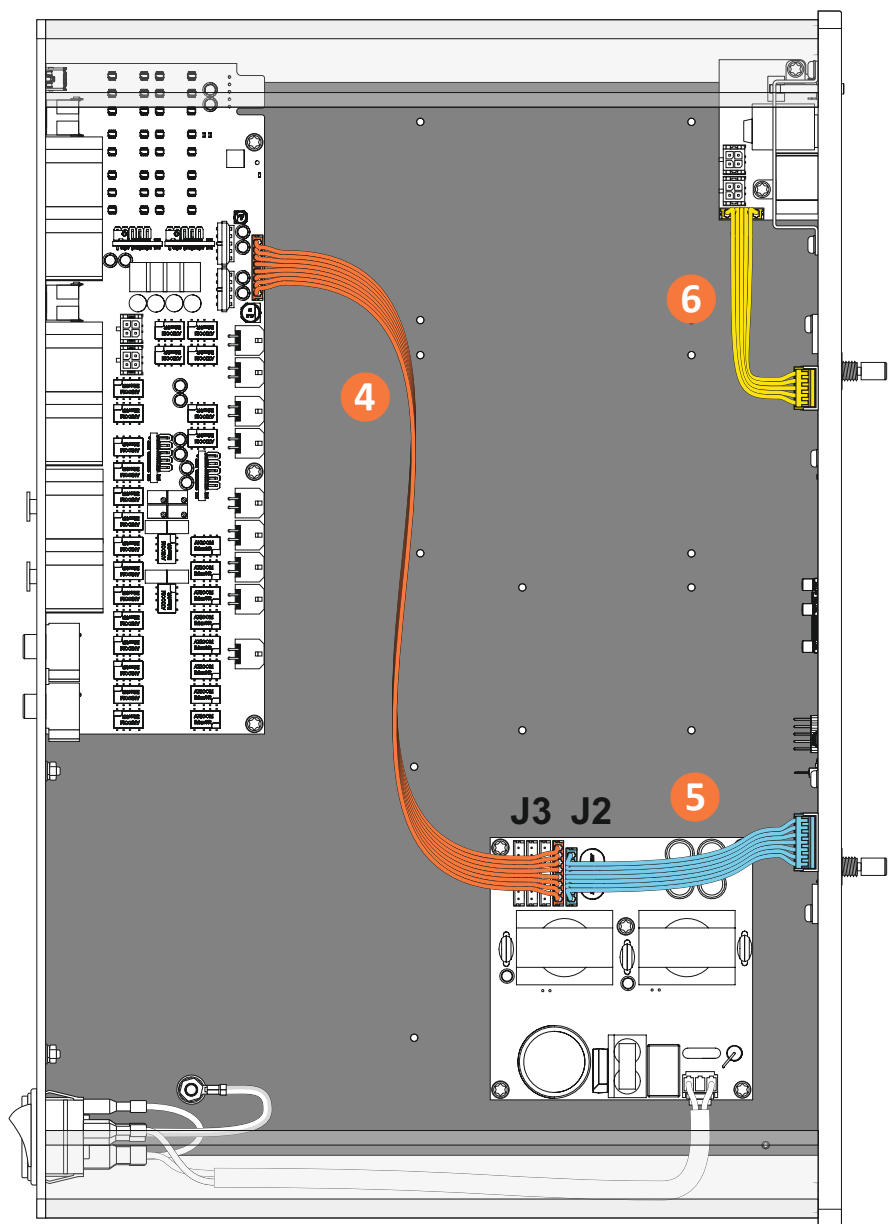
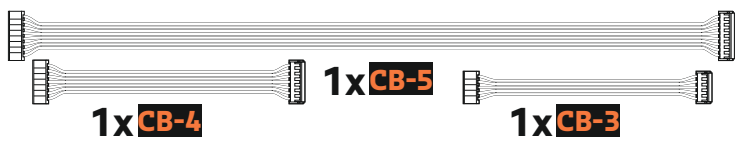



2x **CB-7**

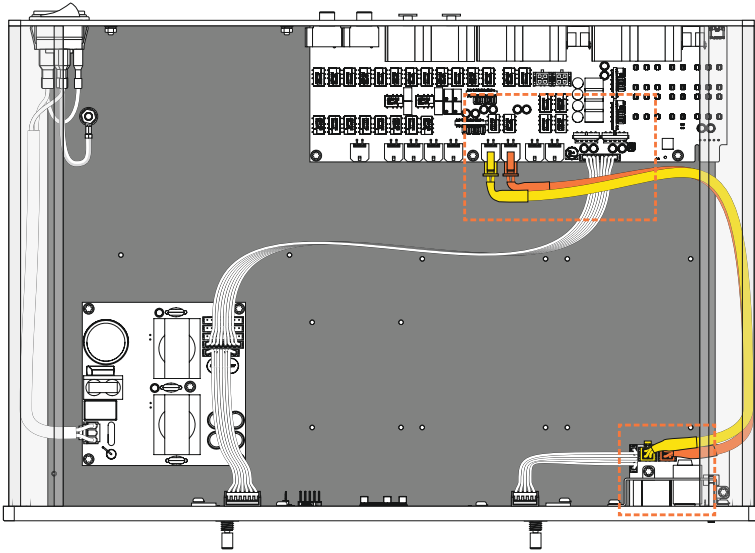

"HP Right"

7

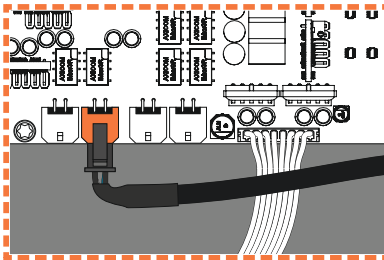

"Right"

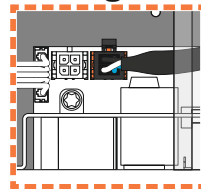

"HP Left"

8

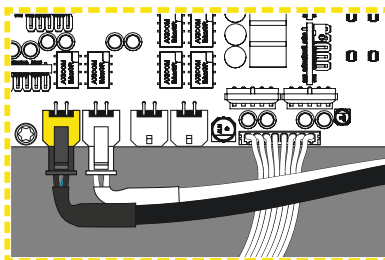

"Left"

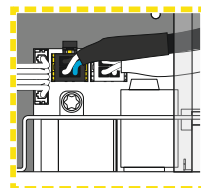

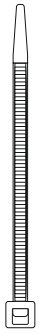

2x **MB-1**

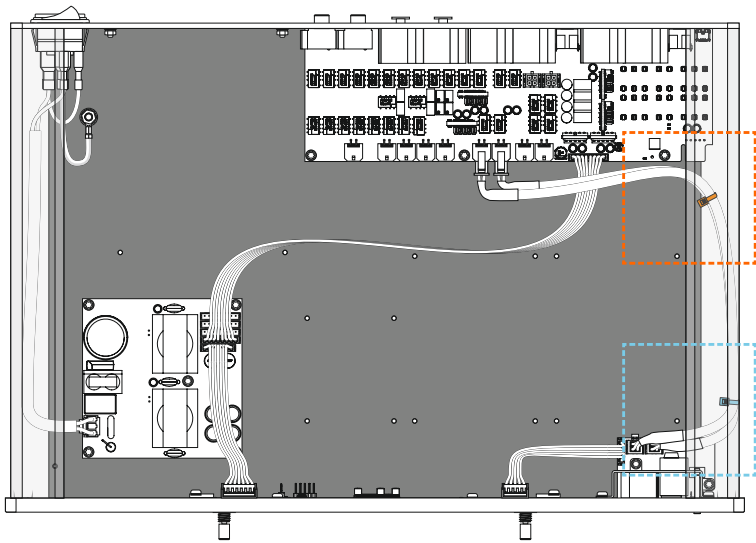

9

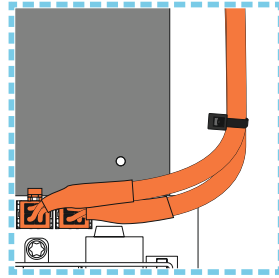
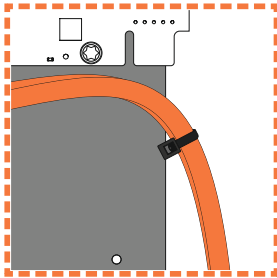
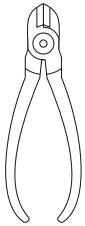

Lid & Frontpanel



M3x8

2x **MB-12**

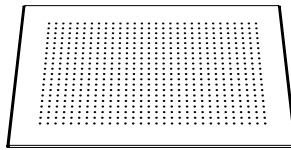

1x **CA-2**



2x **CA-6**

1

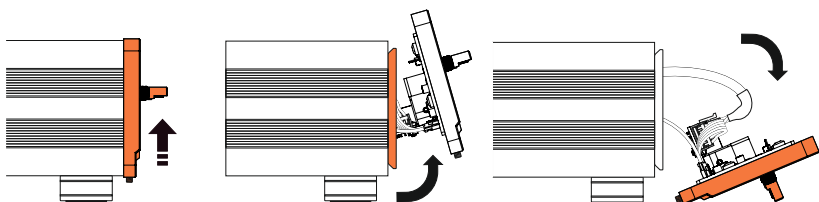

2

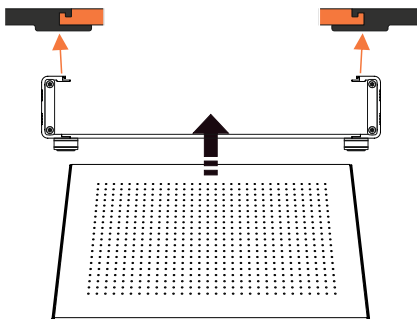
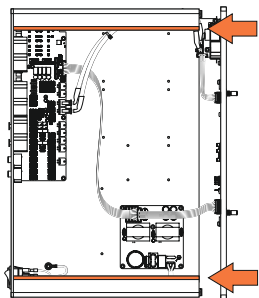

3

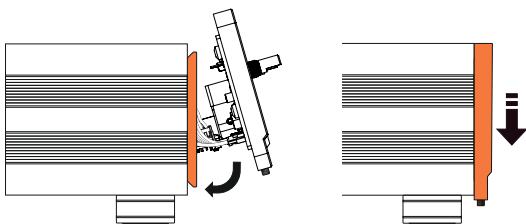
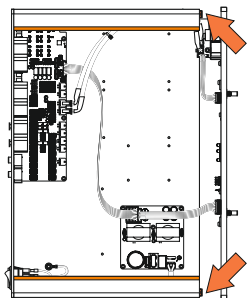

4

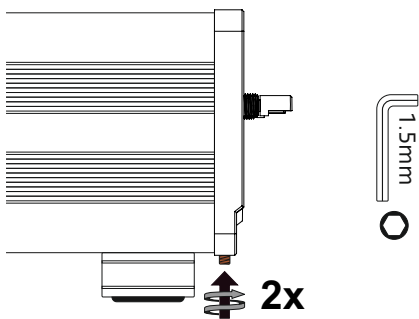
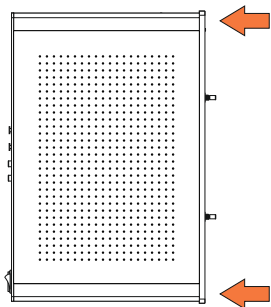

5

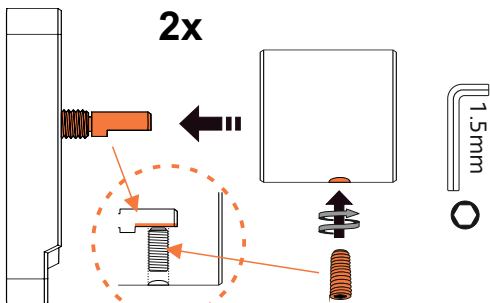
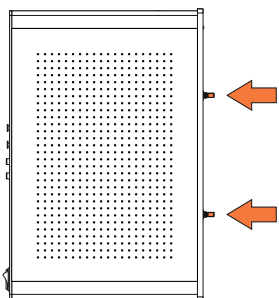

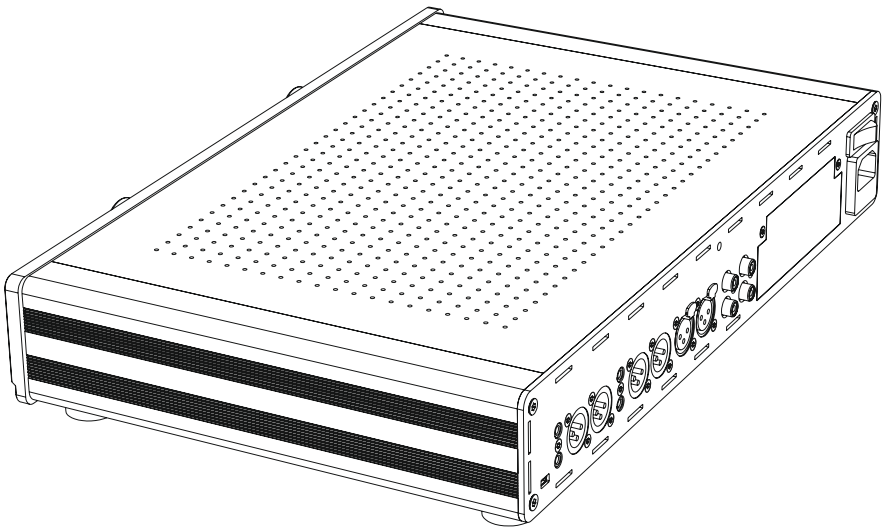
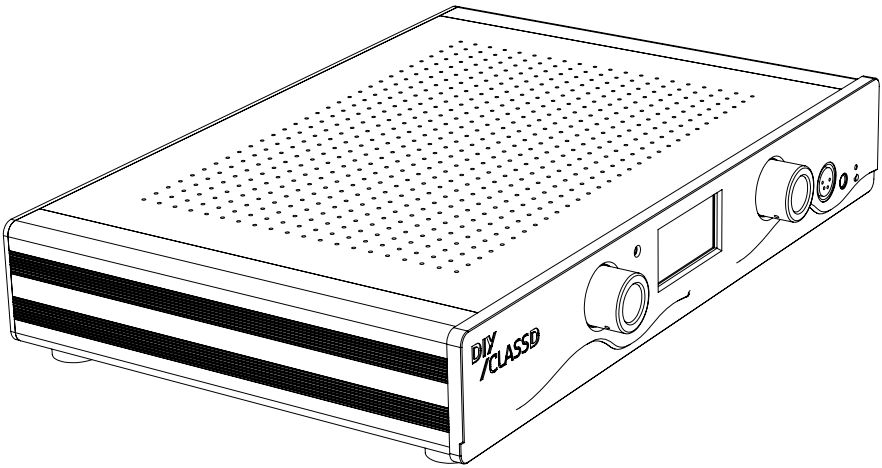

Support

We work continuously to improve your experience with our products. If you have suggestions, remarks or found a bug, please contact us.

If you have any problem with your Pre-amplifier kit please consult the user guide. If the user guide is not sufficient in order to solve your problem please contact Hypex support department. See 'contact information' at the back of this document and on our website.

Do you need additional assistance with assembling your Pre-amplifier kit? Watch our assembly instruction video at the product page on our website.

Visit our website!

The latest datasheets and manuals can be found there. Look into our FAQ and if you can not find the answer there, you can also contact us and we will be happy to assist you!

Limited Warranty

DIYClassD.com warrants this device for a period of two years after the original date of purchase against defects due to faulty workmanship or materials arising from normal use of the device. The warranty covers working parts that affect the function of the device. It does NOT cover cosmetic deterioration caused by fair wear and tear, or damage caused by accident, misuse or neglect. Any attempt to modify or take apart the device (or its accessories) will void the warranty.

If you discover a defect, notify DIYClassD.com during the warranty period. Claims under warranty must be supported by reasonable evidence that the date of the claim is within the warranty period. To validate your warranty, please keep your original purchase receipt together with these warranty conditions for the duration of the warranty period. Replacement products claimed under warranty are not entitled to renewed 2-year warranty coverage.

Date of purchase:

Disclaimer

Hypex Electronics BV, its affiliates, agents, and employees, and all persons acting on its or their behalf (collectively, "Hypex Electronics"), disclaim any and all liability for any errors, inaccuracies or incompleteness contained in any datasheet, user guide or in any other disclosure relating to any product.

This DIY Pre-amplifier kit is designed for use of music reproduction only. No representations are made as to fitness for other uses. Except where noted otherwise any specifications given pertain to this DIY Pre-amplifier kit only.

LIFE SUPPORT POLICY: Use of Hypex products in life support equipment or equipment whose failure can reasonably be expected to result in injury or death is not permitted except by explicit written consent from Hypex Electronics BV.

Revisions

Revision		Comment	Date
Doc.	HW.		
01	0100	First release	15-04-2022

Notes



DIYClassD.com

Kattegat 8
9723 JP Groningen, The Netherlands
+31 50 526 4993
sales@diyclassd.com
www.diyclassd.com

